

Finish the dot-to-dot, and draw Jesus on it.

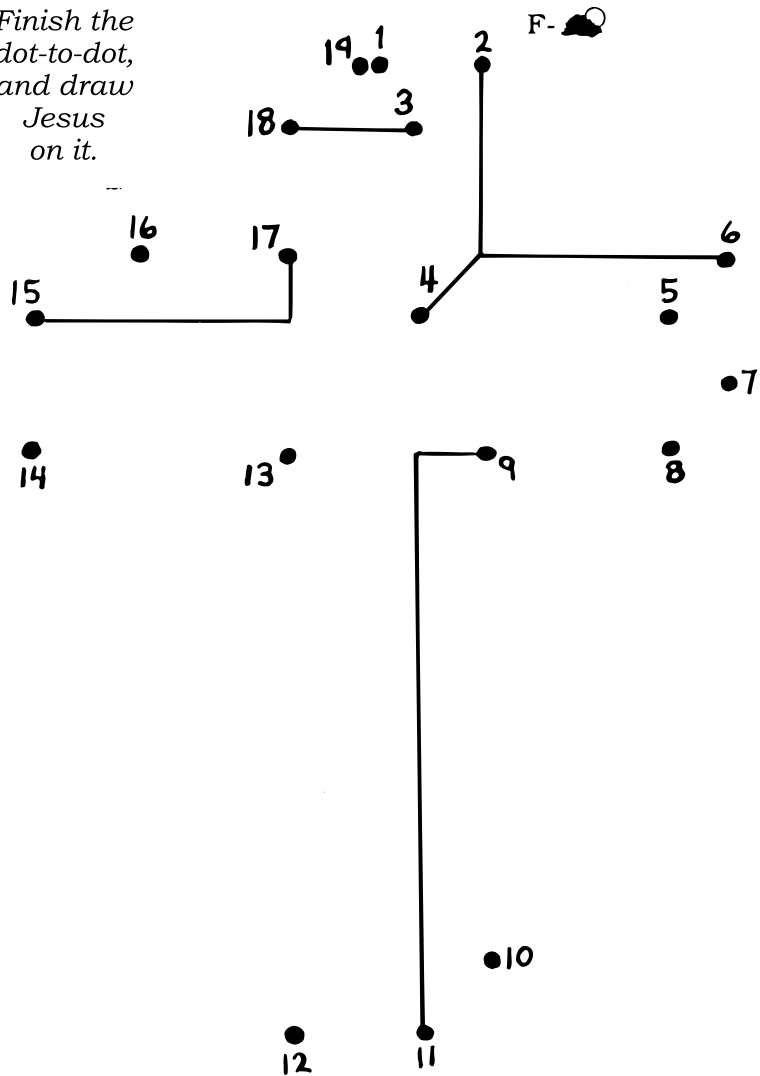

Then the governor, Pontius Pilate, asked them what he should do with Jesus. They said,

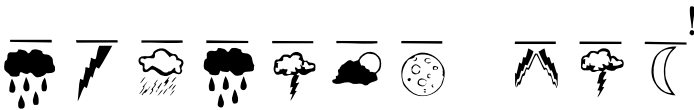

The code keys are hidden all over this issue.

Kidsword

Palm Sunday

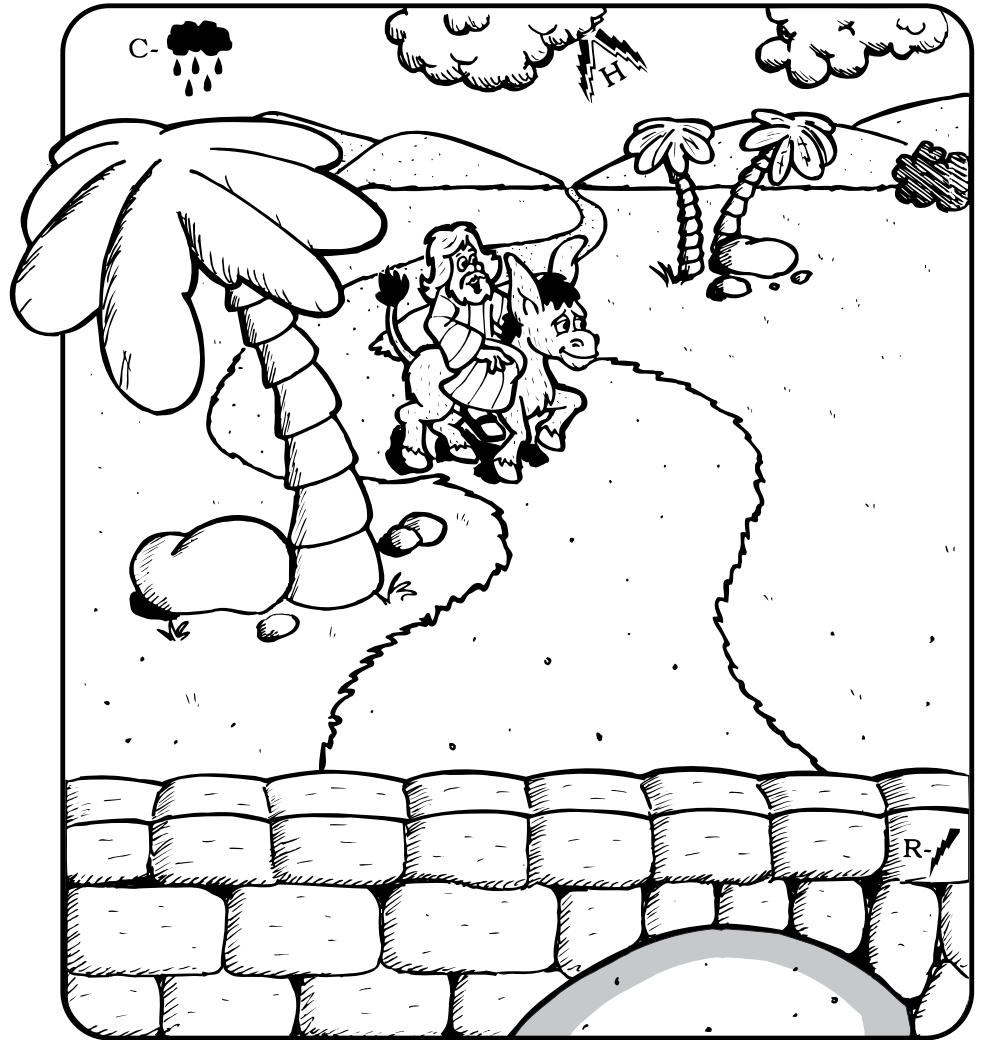

When Jesus entered Jerusalem, the people worshipped him and shouted "Praise God for saving us!" and they waved palm leaves and placed them in his path.

Draw an excited crowd around Jesus waving palm leaves.

Code Key

- A-文 I-上 S-下
- B-又 J-一 T-士
- C-口 L-下 U-川
- D-フ M-夕 Y-川
- E-ハ O-ル
- F-大 P-兄
- H-十 R-二

After Jesus entered the city . . .

He shared the

下 又 不 士

不 川 兄 兄 一 二

with his friends.



FOLLOW JESUS THIS WAY

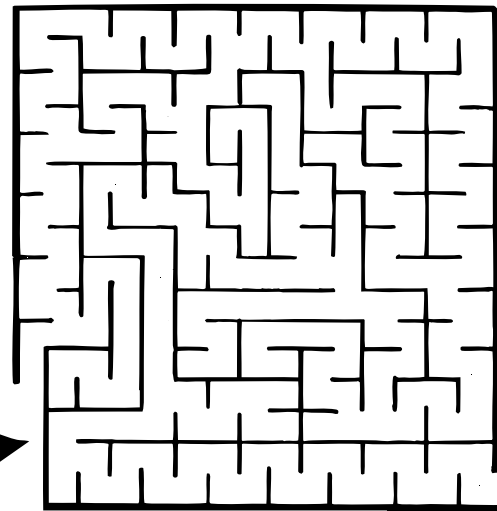

Jesus said to his friends, "Please stay awake and pray with me."

Draw Jesus praying.

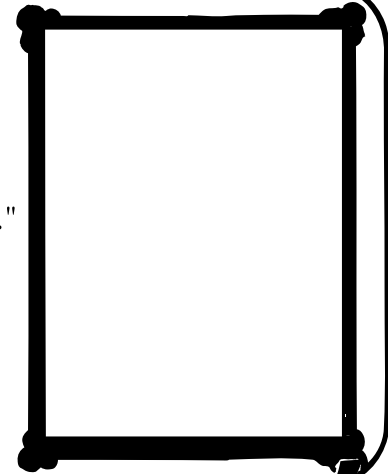

Unscramble the High Priest's words.

AER UOY ETH HCIRTS, ETH ONS FO GDO?

YOU HAVE SAID SO.



U-

Jesus is arrested!

Which one of his friends betrayed him?

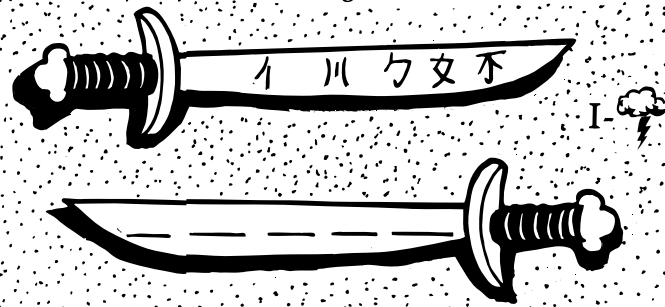

一 川 夕 女 不

I-

But his friends fell asleep.

Draw sleeping faces on them.

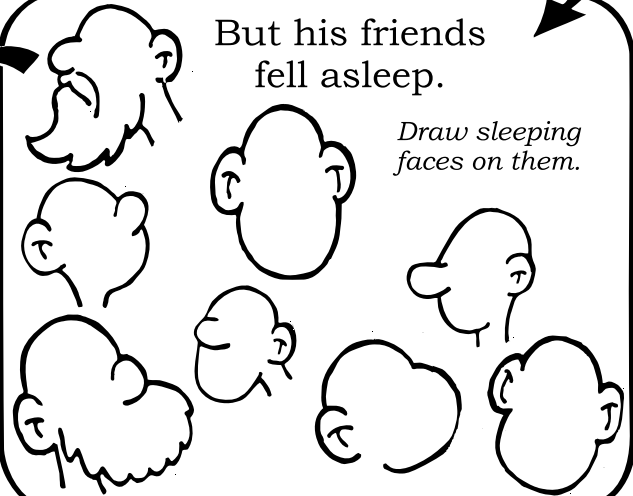

Then they took Jesus to the Roman governor,

Some ⁶ eople told lies about J³ sus. The High Pries¹ said he should be killed. One of Jesus' best f⁸ iends said he didn't even know him.

I DON'T KNOW THE MAN!



His friends name was

--	--	--	--	--

6 3 1 3 8

Fill in the missing letters above, then put them in the same-numbered boxes below.

ENTER HERE

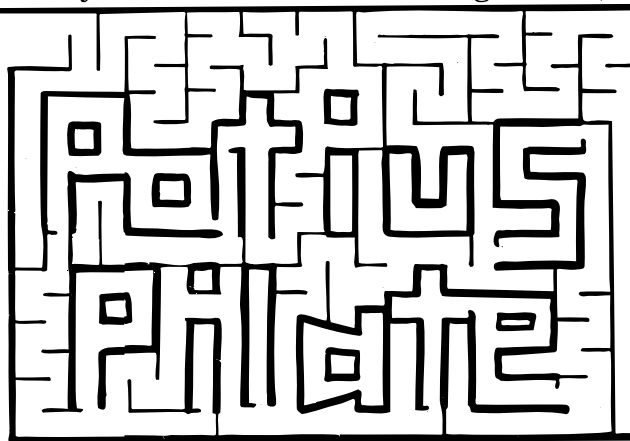

ARE YOU A KING!?



YOU HAVE SAID SO.



M-

Then they led him out and showed him to the crowd.